

All Raster Art (jpg, tiff, pbg, etc.) must be at least **100 DPI** at print size.

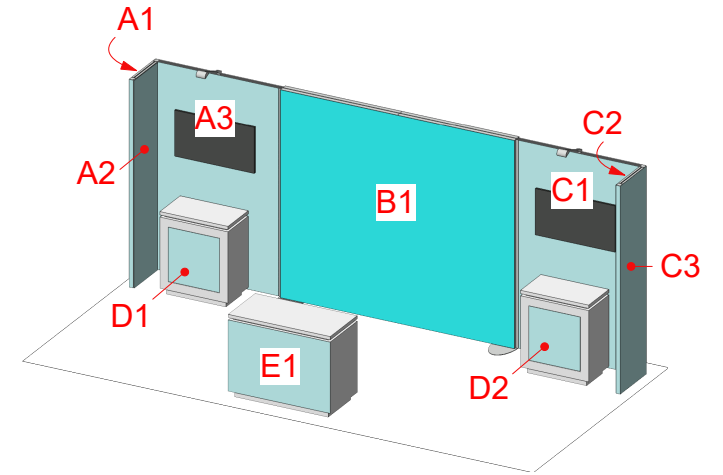

A1  
SEG Graphic  
Safe/Live Area  
25.134" W  
x 94.843" H  
Image Area  
27.134" W  
x 96.843" H

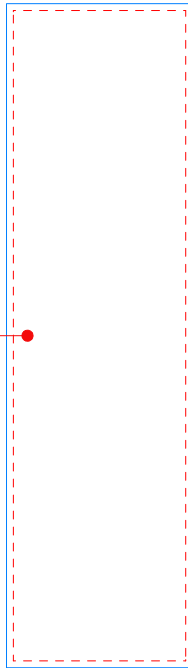

A2  
SEG Graphic  
Safe/Live Area  
20.921" W  
x 94.843" H  
Image Area  
22.921" W  
x 96.843" H

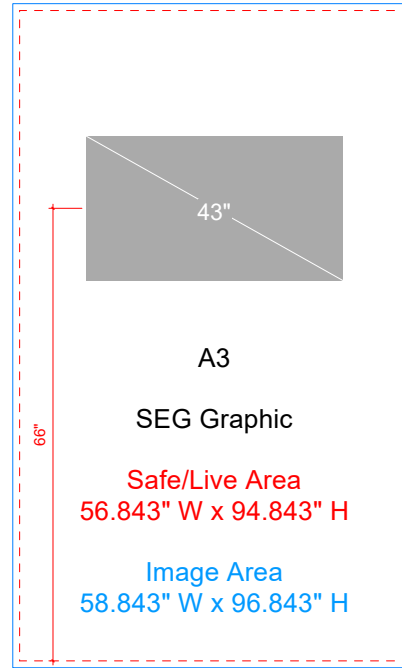
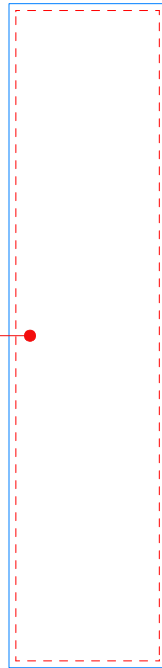

All Raster Art (jpg, tiff, pbg, etc.) must be at least **100 DPI** at print size.

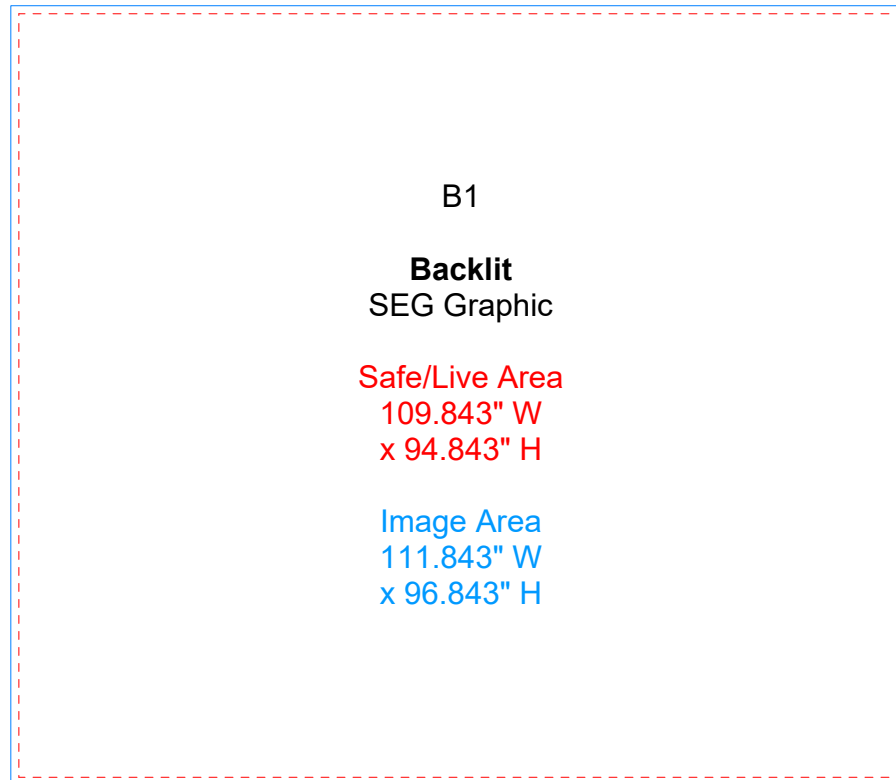
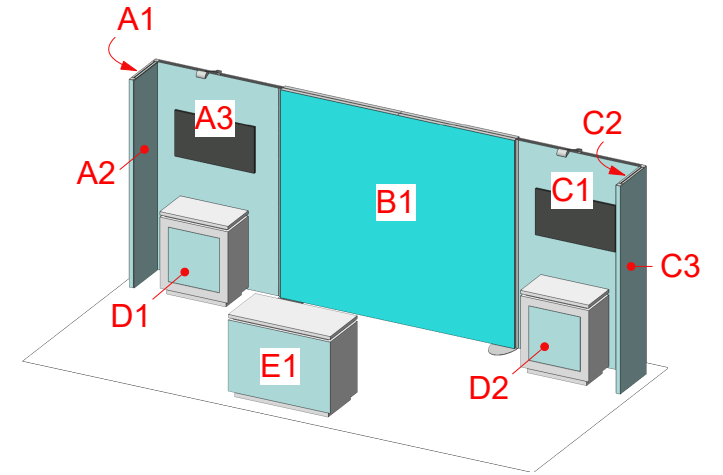

All Raster Art (jpg, tiff, pbg, etc.) must be at least **100 DPI** at print size.

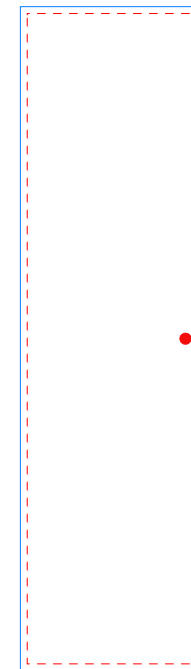
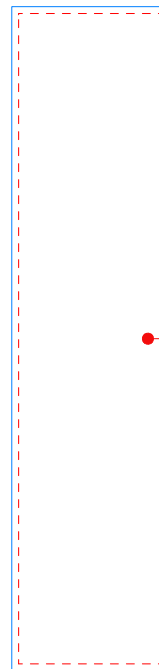
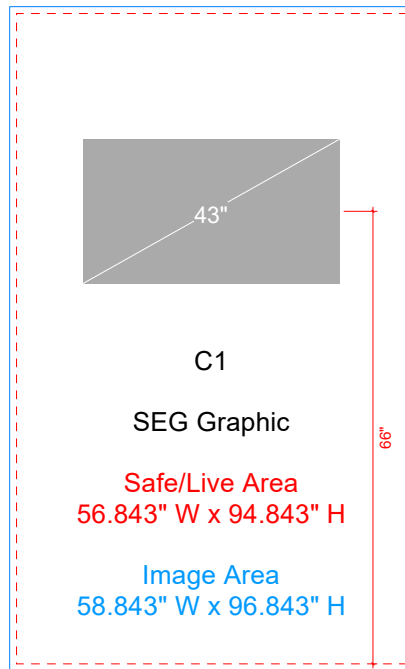
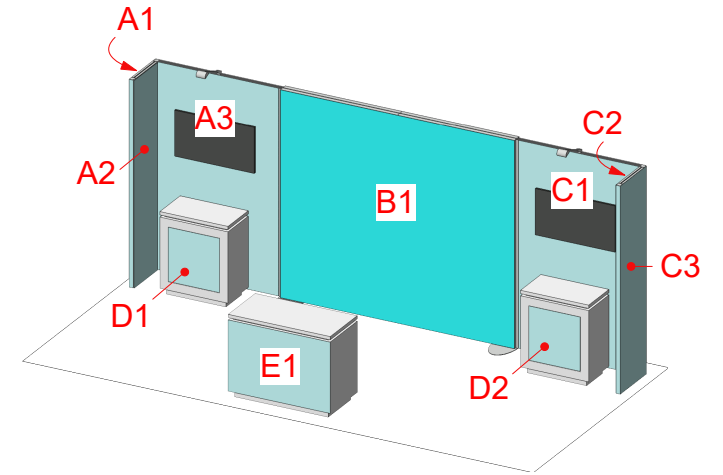

All Raster Art (jpg, tiff, pbg, etc.) must be at least **100 DPI** at print size.

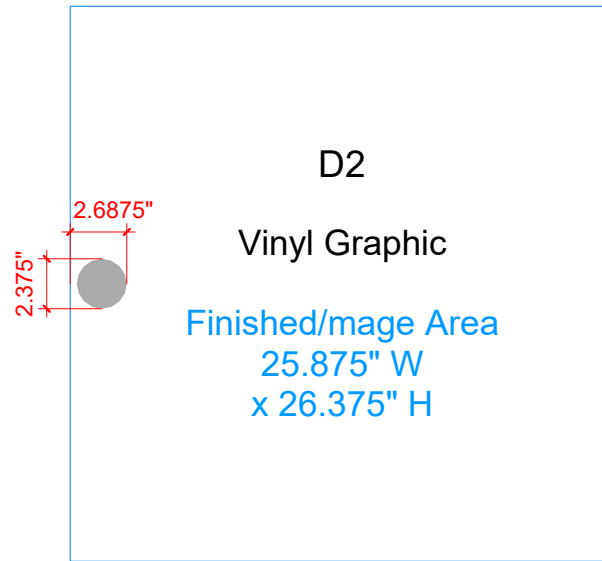
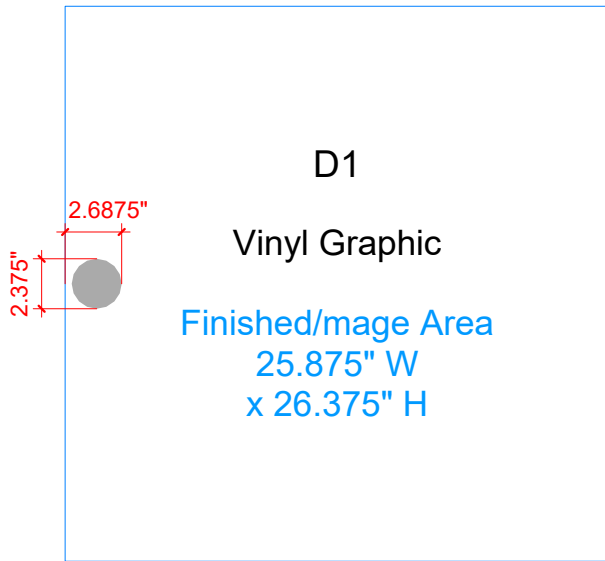
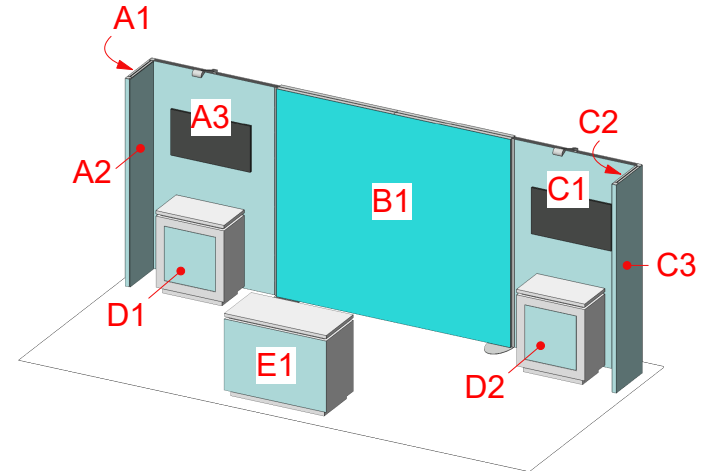

Add 2" Bleed to Vinyl Graphics

All Raster Art (jpg, tiff, pbg, etc.) must be at least **100 DPI** at print size.

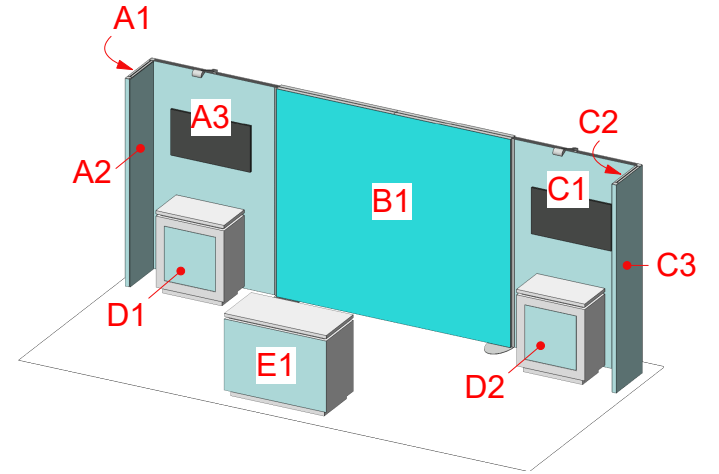

Add 2" Bleed to Vinyl Graphics